



## Industrial Vacuum Accessories



1150 Davis Road, Suite J • Elgin, IL 60123  
(800) 788-8867 • [info@lorchem.com](mailto:info@lorchem.com) • [www.lorchem.com](http://www.lorchem.com)

*We Know How To Get Things* **CLEAN**

# Nilfisk CFM Accessory Catalog

This catalog highlights the most popular Nilfisk CFM industrial vacuum accessories. The guide below makes finding the most appropriate accessory easy – from filtration and collection down to finishing tools.

The range of accessories is extensive and updated continuously, therefore this catalog cannot show the entire Nilfisk CFM product offering. Contact your local sales manager, call 1-800-NILFISK or email [USPAemailorders@nilfisk.com](mailto:USPAemailorders@nilfisk.com) to find a full range of accessories.

- |   |  |  |
|---|--|--|
| <b>A</b> Filtration – <i>pg. 3</i>              | <b>B</b> Collection – <i>pg. 3</i>             | <b>C</b> Inlet & Accessory Couplers – <i>pg. 4</i>                         |
| <b>D</b> Hoses & Cuffs – <i>pg. 5</i>           | <b>E</b> Wands & Fittings – <i>pg. 6</i>       | <b>F</b> Brushes – <i>pg. 7</i>  |
| <b>G</b> Finishing Tools – <i>pg. 8</i>         | <b>H</b> Floor Nozzles – <i>pg. 9</i>          | <b>I</b> Explosion-Proof / Dust Ignition-Proof Accessories – <i>pg. 10</i> |
| <b>J</b> Overhead Cleaning Kits – <i>pg. 11</i> | <b>K</b> Hot Oven Cleaning Kit – <i>pg. 11</i> |  |

Reminder: Only the most popular accessories are represented. Contact us for additional diameters, materials and more.

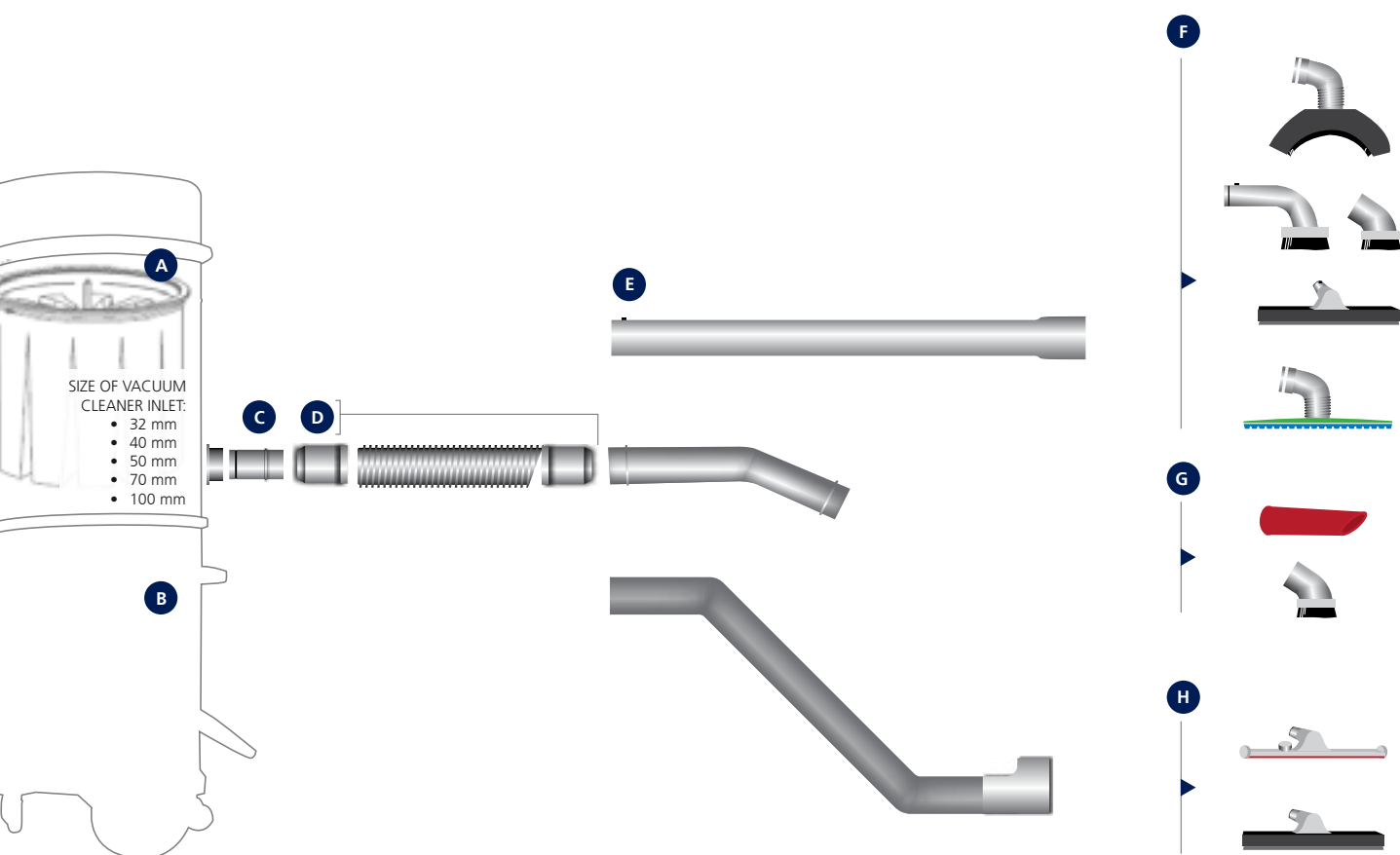

## A. Filtration

Efficient filtration is critical to the success of your industrial vacuum cleaner. Nilfisk CFM uses the highest quality filters designed to safely collect nuisance and hazardous materials. A multi-stage, graduated filtration system is built into every Nilfisk CFM vacuum, which can include a collection bag, main filter, microfilter, and HEPA or ULPA filtration.

**Filter options vary by vacuum and application. Please contact your local sales manager, call 1-800-NILFISK or email [USPAemailorders@nilfisk.com](mailto:USPAemailorders@nilfisk.com) to inquire about the right filter for your needs.**

			
<p><b>Star Filters</b> Available in polyester, polyester and polyurethane blend, Nomex®, PTFE, antistatic, and various sizes</p>	<p><b>Bag Filters</b> Available in polyester, polyester and polyurethane blend, Nomex®, PTFE, antistatic, and various sizes</p>	<p><b>Cartridge Filters</b> Available in antistatic polyester and PTFE</p>	<p><b>HEPA / ULPA Filters</b> Upstream and downstream HEPA and ULPA filters and installation kits</p>

## B. Collection

Nilfisk CFM offers a variety of collection options to aid in filtration and help contain toxic materials. If you are vacuuming dust or powders, it is imperative to consider collection and disposal so you do not risk contact with potent materials or put debris back into the air.

**Collection options vary by vacuum and application. Please contact your local sales manager, call 1-800-NILFISK or email [USPAemailorders@nilfisk.com](mailto:USPAemailorders@nilfisk.com) to inquire about the right collection option for your needs.**

		
<p><b>Collection Bags</b> Available in paper and synthetic materials, and in various sizes</p>	<p><b>Container Liners</b> Available in standard and conductive materials, and in various sizes; requires liner adapter kit</p>	<p><b>SAFE-PAK™ Collection Container</b> Disposable HEPA-filtered collection container for safe removal of potent compounds; available in various sizes</p>

## C. Inlet & Accessory Couplers

Inlet Coupler	Description	Fitment Diameter (mm)	Galvanized Steel	Stainless Steel	Part #	Notes
	Inlet Coupler	40	•		7-21005	(1) internal flange; (1) external flange
			•		7-22229	
		50	•		7-21003	
			•		7-22230	
		70	•		7-21001	
			•		7-22231	

\*Inlet coupler with flow regulator or quick-disconnect also available. Contact customer service for more information.

Accessory Coupler	Description	Fitment Diameter (mm)	Galvanized Steel	Stainless Steel	Part #	Notes
	Accessory Coupler	40	•		01719620	no flanges
		40	•		7-21004	(2) external flanges
			•		7-22240	
		50	•		7-21002	
			•		7-22241	
		70	•		7-21000	
•			7-22242			

\*Accessory coupler with 90-degree angle also available. Contact customer service for more information.



Inlet Coupler with Reduction	Description	Fitment Diameter (mm)	Galvanized Steel	Stainless Steel	Part #	Notes
	Inlet Reducer	50-40	•		7-22000	(1) internal flange; (1) external flange
			•		7-22223	
		70-40	•		7-22309	
			•		7-22002	
		70-50	•		7-22224	
			•		7-22001	
			•		7-22225	

\*Inlet reducers with flow regulation and various sizes also available. Contact customer service for more information.

Multi-User Coupler	Description	Fitment Diameter (mm)	Galvanized Steel	Stainless Steel	Part #	Notes
	Y-Connector (Bifurcation w/ reduction)	50-40-40	•		7-22060	(1) internal flange
		70-40-40	•		7-22111	
		70-50-50	•		7-22064	

\*Additional sizes, materials and features are available, including stainless steel and flow regulation. Trifurcation couplers also available. Contact customer service for more information.

## D. Hoses & Cuffs

Standard Gray Plastic Hose & Cuffs	Description	Fitment Diameter (mm)	Bend Radius (in.)	Temp. Rating °F	Part #	Notes
	Gray Plastic Hose (per meter)	40	6.50	-30 / 140	81813800	Ethyl vinyl acetate construction; for general-purpose use. Max. order length: 15 meters
		50	8.50	-30 / 140	81815000	
		70	9.84	5 / 140	7-24026	Plastic-coated PVC w/ smooth lining for dust & non-abrasive materials. Max. order length: 15 meters
	Gray Plastic Hose Cuff	40	-	-	01719615	Use with 81813800 hose
		50	-	-	01746306	Use with 81815000 hose
		70	-	-	7-20003	Use with 7-24026 hose

\*Hoses are also available in standard lengths with cuffs attached. Contact customer service for more information.

Antistatic Hose & Cuffs	Description	Fitment Diameter (mm)	Bend Radius (in.)	Temp. Rating °F	Part #	Notes	
	15' Black Antistatic Hose w/ Cuffs	40	5.00	-30 / 140	01716215	Carbon-impregnated ethyl vinyl acetate construction; 10 <sup>3</sup> - 10 <sup>6</sup> ohms resistance. Max. order length: 15 meters	
	Black Antistatic Hose (per meter)				01716200		
	20' Black Antistatic Hose w/ Cuffs	50	7.00	-30 / 140	01716420		
	Black Antistatic Hose (per meter)				01716400		
	Black Antistatic Hose Cuff	40	-	-	01716300		Use with 01716200 hose
		50	-	-	01716500		Use with 01716400 hose

\*Swivel cuffs are also available. Contact customer service for more information.

Food-Grade Hose & Cuffs	Description	Fitment Diameter (mm)	Bend Radius (in.)	Temp. Rating °F	Part #	Notes	
	Clear Antistatic Food-Grade Hose (per meter)	40	3.48	-22 / 195; intermittent to 260	7-24110F	FDA-approved polyurethane construction; oil & abrasion-resistant; steel wire reinforced. Max. order length: 15 meters	
		70	4.68		7-24112F		
	Thin-Wall (0.0275") Clear Antistatic Food-Grade Hose (per meter)	50	2.32		01716401		
	Thick-Wall (0.055") Clear Antistatic Food-Grade Hose (per meter)	50	3.48		7-24111F		
	Antistatic Hose Cuff	40	-		-	40000212	Use with 7-24111F hose or 01716401 hose
		50	-		-	7-20309F	Use with 7-24110F hose
70		-	-	7-20310	Use with 7-24112F hose		

\*Additional hose materials are available, including flexible steel and neoprene. Contact customer service for more information.

Reminder: Only the most popular accessories are represented. Contact us for additional diameters, materials and more.

# E. Wands & Fittings

Photo Ref.	Description	Fitment Diameter (mm)	Feature					Material						Part #	Notes
			Overhead clean	Antistatic	Explosion-proof	Food-Grade	High Temp.	Rubber	Plastic	Chromed	Aluminum	Galvanized steel	Stainless steel		
A	Double-Curved Wand	40			•	•					•		7-22026	(1) quick-disconnect fitting	
		50			•	•					•		40000215		
						•	•						•		7-22025
		70									•		40000222		
B	Straight Food-Grade Aluminum Extension Wand	40	•		•	•					•		01769300	5' length	
													01769315	10' length	
		50	•		•	•					•		01769320	5' length	
				•		•	•						•	01769335	10' length
	Curved Food-Grade Aluminum Extension Wand	40	•		•	•					•		01769310	Long bend for hard-to-reach areas	
		50	•		•	•					•		01769330		
	Compression Coupler	40	•		•	•		•					•	01769350	Connects extension wands
		50	•		•	•		•					•	20659000	

\*Additional wands available, including high-temperature aluminum extensions and conductive plastic. Contact customer service for more information.

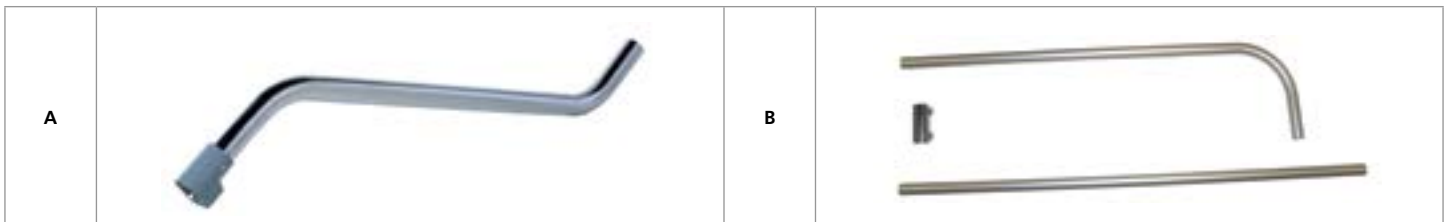

Extension Fitting	Description	Fitment Diameter (mm)	Galvanized Steel	Stainless Steel	Part #	Notes
	Extension Fitting	40-38	•		4072200389	(1) internal flange; (1) quick-fit coupling with harmonic spring; (1) external flange. Use as a connecting element between quick-fit extensions with harmonic springs and colored floor nozzles and brushes.
		50	•		4072200388	
		50-40	•		4072200387	

Curved Tube	Description	Fitment Diameter (mm)	Galvanized Steel	Stainless Steel	Part #	Notes
	Curved Tube	40	•		7-21013	(2) external flanges
					•	
		50	•		7-21012	
					•	
70	•		7-21032			

\*Curved tube with reduction also available. Contact customer service for more information.

# F. Brushes

Photo Ref.	Description	Fitment Diameter (mm)	Principal Width (in.)	Feature					Material					Part #	Notes		
				Overhead clean	Antistatic	Explosion-proof	Food-Grade	High Temp.	Rubber	Plastic	Chromed	Aluminum	Galvanized steel			Stainless steel	
A	Food-Grade Plastic Dust Brush w/ Swivel Head, in Black.	40	3		•		•			•	•					10950200	Nitrile butadiene rubber (NBR) w/ black polypropylene bristles. Also available with <b>red, green, blue, white,</b> and <b>yellow</b> polypropylene bristles. Call Customer Service for Part numbers.
		50			•		•			•	•					10643200	
	Colored Brush Insert Spare Part, in Black.	40 & 50	3		•		•			•	•					80630800	Brush insert w/ black polypropylene bristles. Also available with <b>red, green, blue, white,</b> and <b>yellow</b> polypropylene bristles. Call Customer Service for Part numbers
B	Food-Grade Wall Brush, in Black	40	12	•	•		•			•	•			•	•	22431602	With black polypropylene bristles & rubber lip. Also available with <b>blue</b> and <b>yellow</b> polypropylene bristles. Call Customer Service for Part numbers.
		50		•	•		•			•	•			•	•	22434202	
C	Food-Grade Pipe Brush, in Black.	40	4	•	•		•			•	•			•	•	22430902	With black polypropylene bristles & rubber lip. Also available with <b>blue</b> and <b>yellow</b> polypropylene bristles. Call Customer Service for Part numbers.
			8	•	•		•			•	•			•	•	22431002	
			12	•	•		•			•	•			•	•	22431102	
		50	4	•	•		•			•	•			•	•	22433702	
			8	•	•		•			•	•			•	•	22433802	
			12	•	•		•			•	•			•	•	22433902	
D	Aluminum Dust Brush	40	3			•				•		•			01719401	With conductive bristles	
E	Wall Brush	40	16	•						•				•		7-22195	Includes bristles, 30° elbow fitting, (1) internal flange, & quick-fit coupling with harmonic spring; PVC construction
		50		•						•				•		7-22198	

\*NOTE: Part numbers are for black brushes only. Contact customer service for part numbers of other colors. Additional materials and diameters also available.



# G. Finishing Tools

Photo Ref.	Description	Fitment Diameter (mm)	Principal Width (in.)	Feature					Material					Part #	Notes	
				Overhead clean	Antistatic	Explosion-proof	Food-Grade	High Temp.	Rubber	Plastic	Chromed	Aluminum	Galvanized steel			Stainless steel
A	Crevice Cone	40	-						•						80956200	Gray; 200mm length
		40	-				•		•						80956204	White; 200mm length
		40	-				•		•						80956205	Yellow; 200mm length
B	Tapered Crevice Nozzle	40	0.79 at tip		•				•						7-22142	Conductive black nitrile rubber; includes a galvanized junction fitting; 300mm length
		50			•				•						7-22141	
C	Rubber Nozzle	40	4.72						•				•		7-22155	Gray nitrile rubber; oilproof; toothed profile
D	Rubber Cone	50	-						•						7-21010	Red nitrile rubber; oilproof
E	Conductive Rubber Cone	50	-			•			•						4000221	Black nitrile rubber; oilproof
F	Short Rubber Cone	50	-						•						80650900	Gray nitrile rubber; 9.65" length

\*Additional diameters, features and materials available. Contact customer service for more information.





## H. Floor Nozzles

Photo Ref.	Description	Fitment Diameter (mm)	Principal Width (in.)	Feature					Material					Part #	Notes			
				Overhead clean	Antistatic	Explosion-proof	Food-Grade	High Temp.	Rubber	Plastic	Chromed	Aluminum	Galvanized steel			Stainless steel		
A	Wheeled Floor Nozzle (wet or dry)	40	12											•	7-22171	Includes (2) rubber squeegees, wheel adjuster screw, & (1) internal flange; a quantity of (2) 8-23000 brush inserts must be purchased separately for dry use		
			16												•		7-22030	
		50	12														•	7-22172
			16														•	7-22029
		20			•	•											•	7-22147
50	16													•	40000223	Includes (2) silicone squeegees, wheel adjuster screw, & (1) internal flange		
	Additional Squeegee Inserts (wet)	-	12 & 16											•	8-20086	Includes (1) piece		
		-	20											•	8-20087	Includes (1) piece		
	Additional Brush Inserts (dry)	-	12 & 16											•	8-23000	Includes (1) piece		
		-	20											•	8-23016	Includes (1) piece		

\*Additional diameters, features and materials available. Contact customer service for more information.



Reminder: Only the most popular accessories are represented. Contact us for additional diameters, materials and more.

# I. Explosion-Proof / Dust Ignition-Proof Accessories

## Couplers, Reducers and Wands

Inlet couplers, reducers and wands safe for use with explosion-proof/dust ignition-proof vacuums are listed in sections C. and F. Refer to stainless steel and aluminum parts.

Antistatic Hose & Cuffs	Description	Fitment Diameter (mm)	Bend Radius	Temp. Rating °F	Part #	Notes
	40mm Conductive ( $\leq 10^4$ ohms) Polyurethane Hose (per meter)	40	3.48 in.	-22 / 195; intermittent to 260	7-24115	Spring steel wire with carbon-impregnated polyurethane coating; $10^4$ ohms resistance; Max. order length: 15 meters.
	40mm Antistatic Hose Cuff				40000212	Use with 7-24115 hose
	50mm Conductive ( $\leq 10^4$ ohms) Polyurethane Hose (per meter)	50	4.68 in.	-22 / 195; intermittent to 260	7-24116	Spring steel wire with carbon-impregnated polyurethane coating; $10^4$ ohms resistance; Max. order length: 15 meters.
	50mm Antistatic Hose Cuff				7-20309F	Use with 7-24116 hose

Photo Ref.	Finishing Tools and Brushes for Hazardous Locations	Fitment Diameter (mm)	Principal Width (in.)	Construction Type		Part #	Notes
				Aluminum	Stainless Steel		
A	Wheeled Floor Nozzle	50	16		•	40000223	Includes (2) silicone squeegees, wheel adjuster screw, & (1) internal flange
B	Conductive Rubber Cone	40	-			40000214	Black nitrile rubber; oilproof
		50			40000221		
C	Conductive Rubber Nozzle	50	4.72			7-21080	Black nitrile rubber; oilproof; toothed profile
D	Crevice Nozzle	40	-		•	40000213	(1) external flange; 20" -length
		50			•	40000220	
E	Aluminum Crevice Nozzle	40	-	•		01768900	11" -length
F	Aluminum Dust Brush	40	3		•	01719401	With conductive bristles
		50			•	M50058	
G	EXP Pipe Brush	40	4		•	M50038	With black bristles
		50			•	M50042	
		40	8		•	M50039	
		50			•	M50043	
		40			•	M50040	
H	EXP Wall Brush	40	12		•	M50041	-
		50			•	M50045	



## J. Overhead Cleaning Kits

Photo Ref.	Description	Fitment Diameter (mm)	Kit Includes	Individual Part #	Full Kit Part #
A	Overhead Cleaning Kit	40	3 Meters of Black Conductive Plastic Hose (2) Conductive Hose Cuffs (2) 5' Food Grade Aluminum Extension Wands Curved Food Grade Aluminum Extension Wand (2) Compression Couplings 12" Blue Wall Nozzle 8" Blue Pipe Brush 3" Blue Dust Brush	01716200 01716300 01769300 01769310 01769350 22431607 22431007 10950203	01760440
		50	4 Meters of Black Conductive Plastic Hose (2) Conductive Hose Cuffs (2) 5' Food Grade Aluminum Extension Wands Curved Food Grade Aluminum Extension Wand (2) Couplers 12" Blue Wall Nozzle 8" Blue Pipe Brush 3" Blue Dust Brush	01716400 01716500 01769320 01769330 20659000 22434207 22433807 10643200	01760445

## K. Hot Oven Cleaning Kit

Photo Ref.	Description	Fitment Diameter (mm)	Kit Includes	Individual Part #	Full Kit Part #
B	Hot Oven Cleaning Kit	40	3 Meters of Flexible Steel Hose	7-24031	01760450
			(2) Antistatic Hose Cuffs	40000212	
			10' High-Temperature Extension Wand	7-22267	
			16" Wheeled Oven Cleaning Nozzle	7-22272	



## Safe Choice Commitment

At Nilfisk Industrial Vacuums we understand that you face many risks each day, just by operating your business. That is why Nilfisk is dedicated to helping you make smart choices to keep your facility and your workers safe. Our team of experts is ready to tackle any cleaning challenge – because in a world full of risk, you have to make safe choices.

We are committed to being that safe choice. To learn more visit [nilfiskindustrialvacuums.com/SafeChoice](http://nilfiskindustrialvacuums.com/SafeChoice).

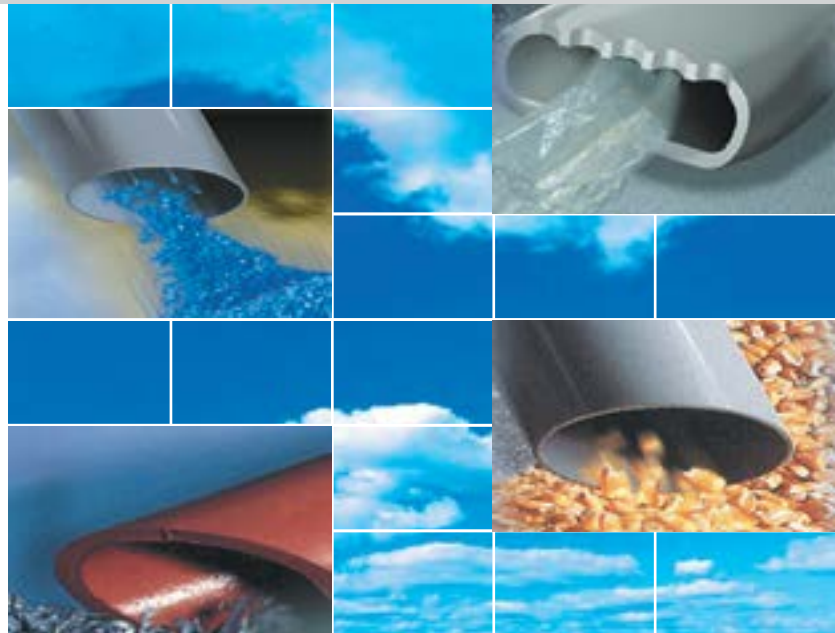

Nilfisk-Advance, Inc.  
Industrial Vacuum Division  
740 Hemlock Rd., Suite 100  
Morgantown, PA 19543



1150 Davis Road, Suite J • Elgin, IL 60123  
(800) 788-8867 • [info@lorchem.com](mailto:info@lorchem.com) • [www.lorchem.com](http://www.lorchem.com)  
*We Know How To Get Things* **CLEAN**